

Article number: 201242459

Description: E+G Retaining magnets with threaded stud GN 52.4-ND-40-M8-E
Neodymium, iron, boron - 80° C, 600N

Measures

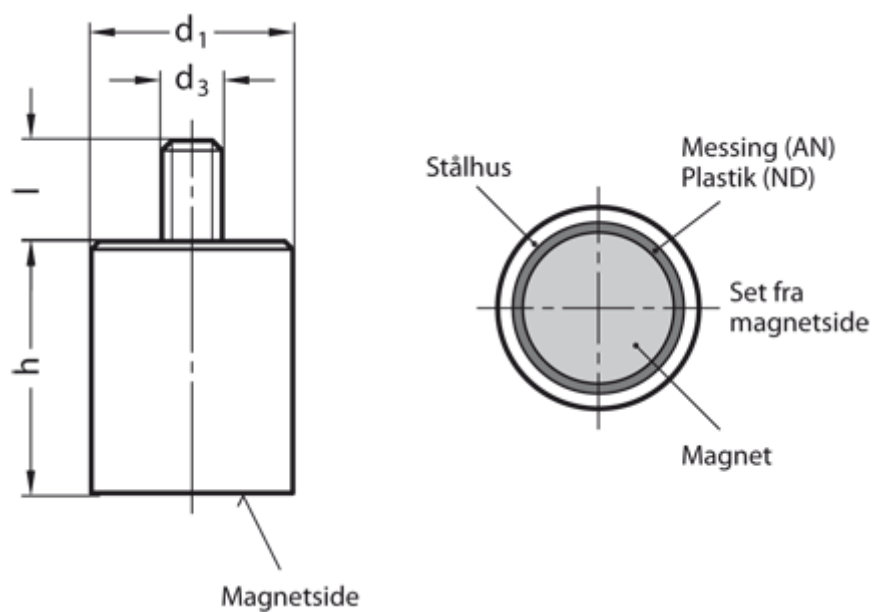

d1	= 40
d3	= M8
h	= 50 ±0,2
Holding force N	= 600.0
l	= 15
Material	= ND Neodym, iron, boron, 80°C